



Data Transfer Unit **USER MANUAL**

DTU-Pro-S

CONTENTS

1. Important Safety Information	02
1.1 Read This First	02
1.2 Safety Instructions	02
1.3 User	02
1.4 Support and Contact Information	02
1.5 Other Information	02
2. Hoymiles Microinverter System	03
2.1 Microinverter	03
2.2 DTU	03
2.3 S-Miles Cloud	03
3. Interface Layout	03
3.1 For Wi-Fi Version	03
3.2 For 4G Version	04
4. Additional Features	05
4.1 Export Management Function (RS485 port)	05
4.2 DRM Port (for Australia and New Zealand only)	05
5. Installation Planning and Preparation	06
5.1 Pre-installation	06
5.2 Dimensions	06
5.3 System Installation Steps	07
6. DTU Installation	08
6.1 Installation Instructions	08
6.2 Online Setting	08
6.3 Complete Installation Map	12
7. Micro Toolkit	13
7.1 Connect to the DTU	13
7.2 Field Commissioning and Data Viewing	14
8. Site Creation on S-Miles Cloud	20
8.1 Site Creation	20
8.2 Customer Login	26
8.3 Browse Station on Webpage	27
8.4 View Phone App	27
9. DTU Replacement	28
10. LED Indicators	29
11. Technical Data	30



1. Important Safety Information

1.1 Read This First

This manual includes important instructions for installing and maintaining the Hoymiles Data Transfer Unit (DTU-Pro-S).

DTU-Pro-S is only compatible with Hoymiles new HMS and HMT series of microinverters.

1.2 Safety Instructions

Symbol	Usage
	This indicates a hazardous situation that can result in deadly electric shocks, serious physical injuries, and fire incidents.
	This indicates that directions must be strictly followed to avoid safety hazards such as equipment damage and personal injury.
	This indicates that the act is forbidden. You should stop, use caution and fully understand the operations explained before proceeding.

- Note that only professionals can install or replace DTU.
- Do not try to repair DTU without Hoymiles' permission. If the DTU is damaged, please send it back to your installer for repair/replacement. Disassembling DTU without Hoymiles' permission will invalidate the remaining warranty period.
- Please read all the instructions and warnings in the technical specifications carefully.
- Do not use Hoymiles products in a way that is not suggested by the manufacturer. Otherwise it can cause death, personal injuries, or equipment damage.

1.3 User

This manual is only for professional installation and maintenance personnel.

1.4 Support and Contact Information

If you have technical queries concerning our products, please contact your installer or distributor. If further technical support is required, please contact our support team at service@hoymiles.com.

For other questions please contact info@hoymiles.com

1.5 Other Information

Product information is subject to change without notice. The user manual will be updated regularly. Please refer to Hoymiles official website at www.hoymiles.com for the latest version.

2. Hoymiles Microinverter System

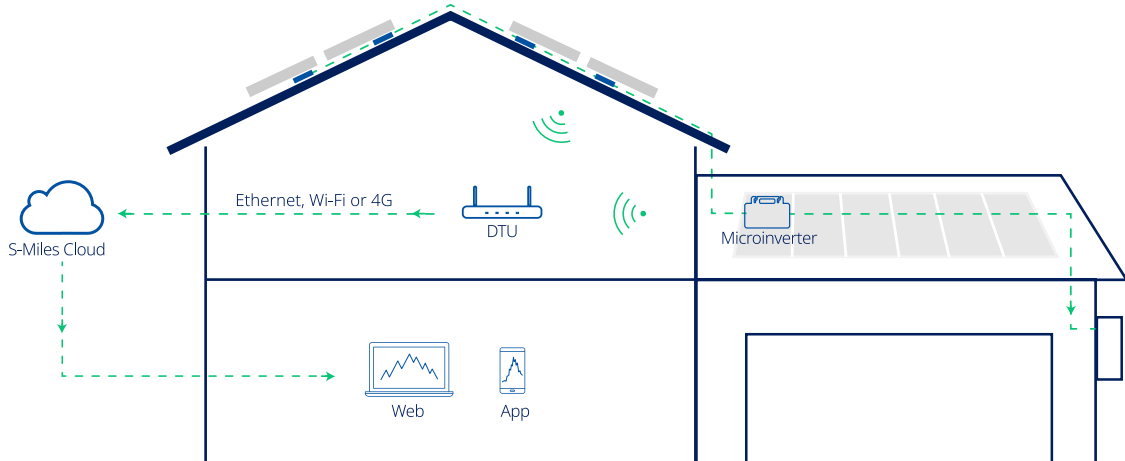

The complete Hoymiles PV microinverter system is composed of PV microinverter, Hoymiles gateway DTU and Hoymiles monitoring system S-Miles Cloud.

The microinverter converts direct current to alternating current and sends each module's power generation and operation data to the DTU.

DTU can communicate with multiple microinverters, collect their operation data, and send them to S-Miles Cloud.

On S-Miles Cloud, you can check the real-time data of each PV module and perform remote operation and maintenance.

2.1 Microinverter

Microinverters convert the DC output of PV modules into grid-compliant AC power. They send their operation data and the output information of PV modules to the DTU, which is the hardware basis of the module-level monitoring. With conversion efficiency up to 96.7% and MPPT efficiency up to 99.9%, Hoymiles microinverters rank among the first class in the industry worldwide.

2.2 DTU

DTU is the key component in Hoymiles microinverter system. It works as the communication gateway between the Hoymiles microinverters and S-Miles Cloud. The DTU communicates with the microinverter in a wireless way and collects the operation data of the system. Meanwhile, the DTU connects to the Internet using different communication options such as Ethernet, Wi-Fi or 4G and communicates with S-Miles Cloud. The operation data of the microinverter system will be uploaded to S-Miles Cloud via DTU.

2.3 S-Miles Cloud

It collects the operation data and status of the microinverters in the system and provides module-level monitoring for the users and maintenance staff. The following diagram shows the Hoymiles Microinverter system.

3. Interface Layout

3.1 For Wi-Fi Version

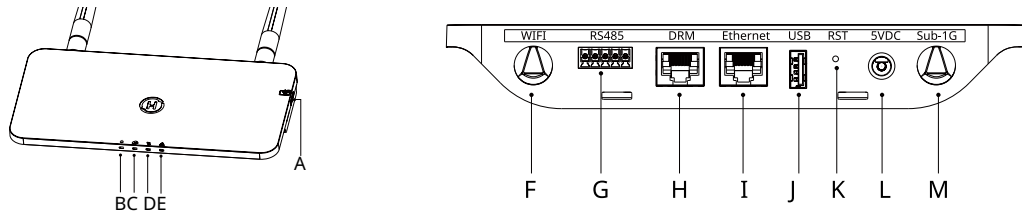

Item	Description
A	SD Card Slot
B	DTU Power Indicator
C	DTU Communication Indicator (with server)
D	DTU Communication Indicator (with microinverter)
E	DTU Alarm Indicator
F	Wi-Fi Antenna
G	RS485
H	DRM Port (for Australia / New Zealand only)
I	Ethernet Port
J	USB Port
K	Reset Bottom
L	Power Port
M	Sub-1G Antenna

3.2 For 4G Version

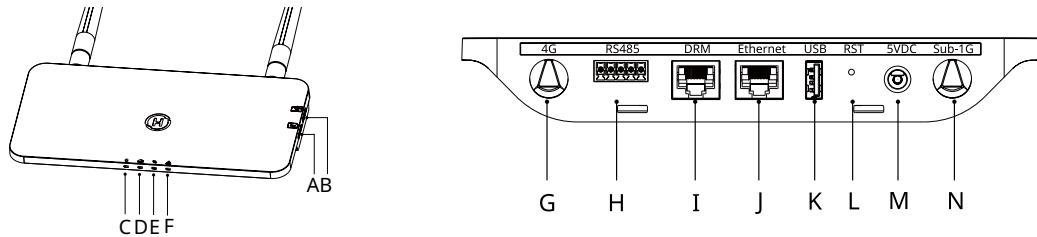

Item	Description
A	SIM Card Slot
B	SD Card Slot
C	DTU Power Indicator
D	DTU Communication Indicator (with server)
E	DTU Communication Indicator (with microinverter)
F	DTU Alarm Indicator
G	4G Antenna
H	RS485
I	DRM Port (For Australia / New Zealand only)
J	Ethernet Port
K	USB Port
L	Reset Bottom
M	Power Port
N	Sub-1G Antenna

4. Additional Features

4.1 Export Management Function (RS485 port)

The Hoymiles Smart Power Export Management can intelligently control the output power of the PV system, and maximize your power generation without violating grid export regulations. At the same time, this system can also accurately display the power and production of the PV system with the measuring meter, so that users can trade the PV production online based on the data on S-Miles Cloud.

In Hoymiles Export Management solution, Hoymiles gateway DTU-Pro-S and additional meter (CT optional) are necessary. In the case of export limitation, the meter can be installed at the load side or the grid side. As shown below, the gateway DTU will dynamically adjust the PV power production according to the export power or load consumption as measured by the meter, so that the export power does not exceed the preset limit. To display the PV production in an accurate way, the meter needs to be installed at the output of the PV system.

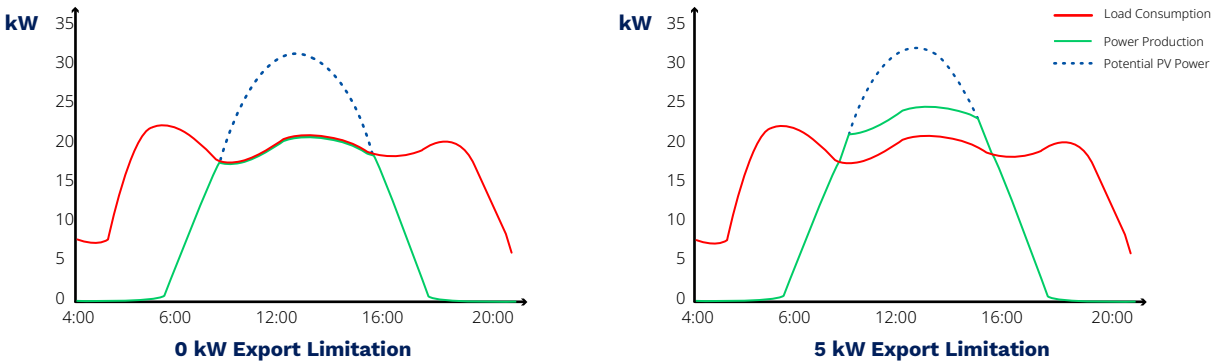

Note: Please refer to Hoymiles technical note “Power Export Management System” for more details.

4.2 DRM Port (for Australia and New Zealand only)

DRM port is provided to support several demand response modes as shown below by connecting external control device with a standard RJ-45 connector. DTU-Pro-S supports DRM0/5/6/7/8 if used with Hoymiles microinverters.

Mode	Requirement
DRM0	Operate the disconnection device
DRM1	Do not consume power
DRM2	Do not consume at more than 50% of rated power
DRM3	Do not consume at more than 75% of rated power AND Source reactive power if capable
DRM4	Increase power consumption (subject to constraints from other active DRMs)
DRM5	Do not generate power
DRM6	Do not generate at more than 50% of rated power
DRM7	Do not generate at more than 75% of rated power AND Sink reactive power if capable
DRM8	Increase power generation (subject to constraints from other active DRMs)

5. Installation Planning and Preparation

5.1 Pre-installation

5.1.1 System Capacity

The DTU-Pro-S is capable of monitoring up to 99 PV modules. If the communication between the DTU and microinverter is affected by the installation conditions, the number of PV modules that the DTU can monitor may be reduced.

Note: The maximum number of modules is only possible in open space when installation conditions detailed in DTU and microinverter manuals are fulfilled and the microinverter and DTU are properly placed apart as required.

5.1.2 Environmental Requirements for DTU Installation:

- The DTU should be installed away from dust, liquid, acidic, or corrosive gas.
- The ambient temperature should be between -20°C and 55°C.

If you plan to install the DTU on the wall, please prepare two #8 (4.166 mm diameter) screws and a screwdriver in advance.

5.2 Dimensions

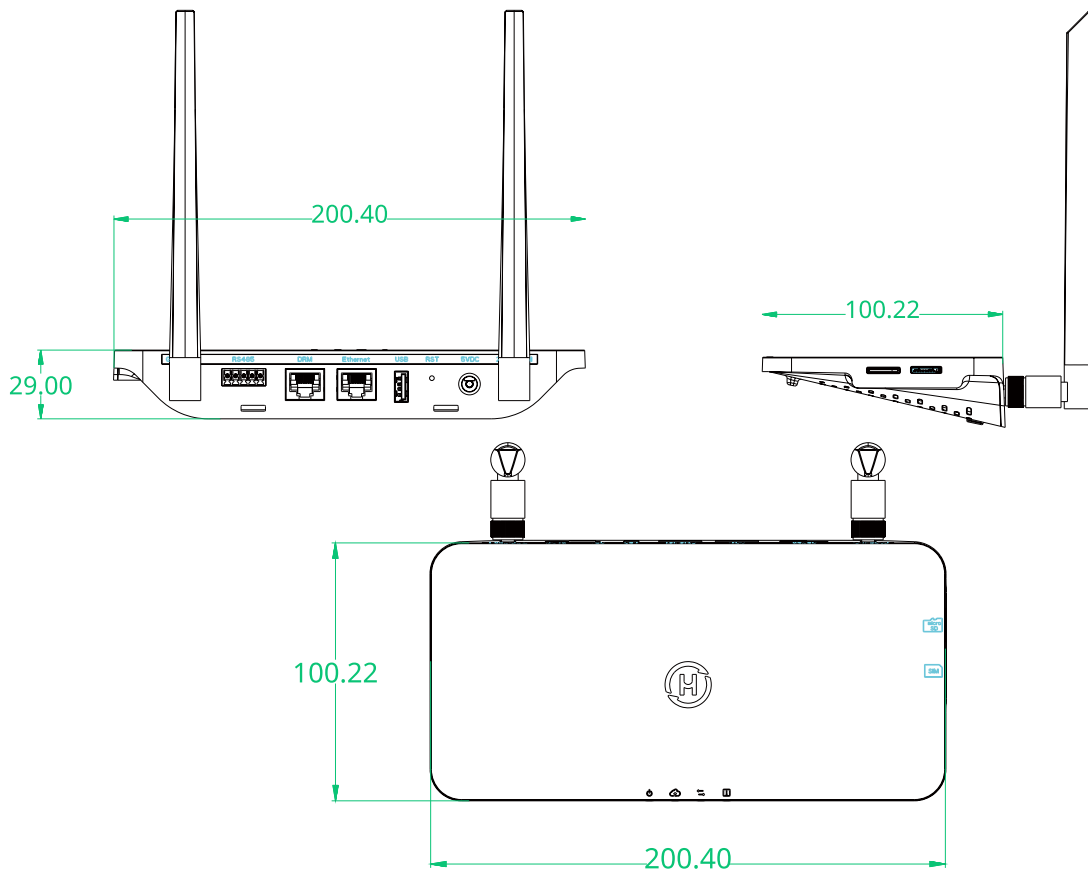

5.3 System Installation Steps

Work that needs to be done on site

Work that can be done either on site or at home. Step 6 must be done correctly in order to complete these steps on site.

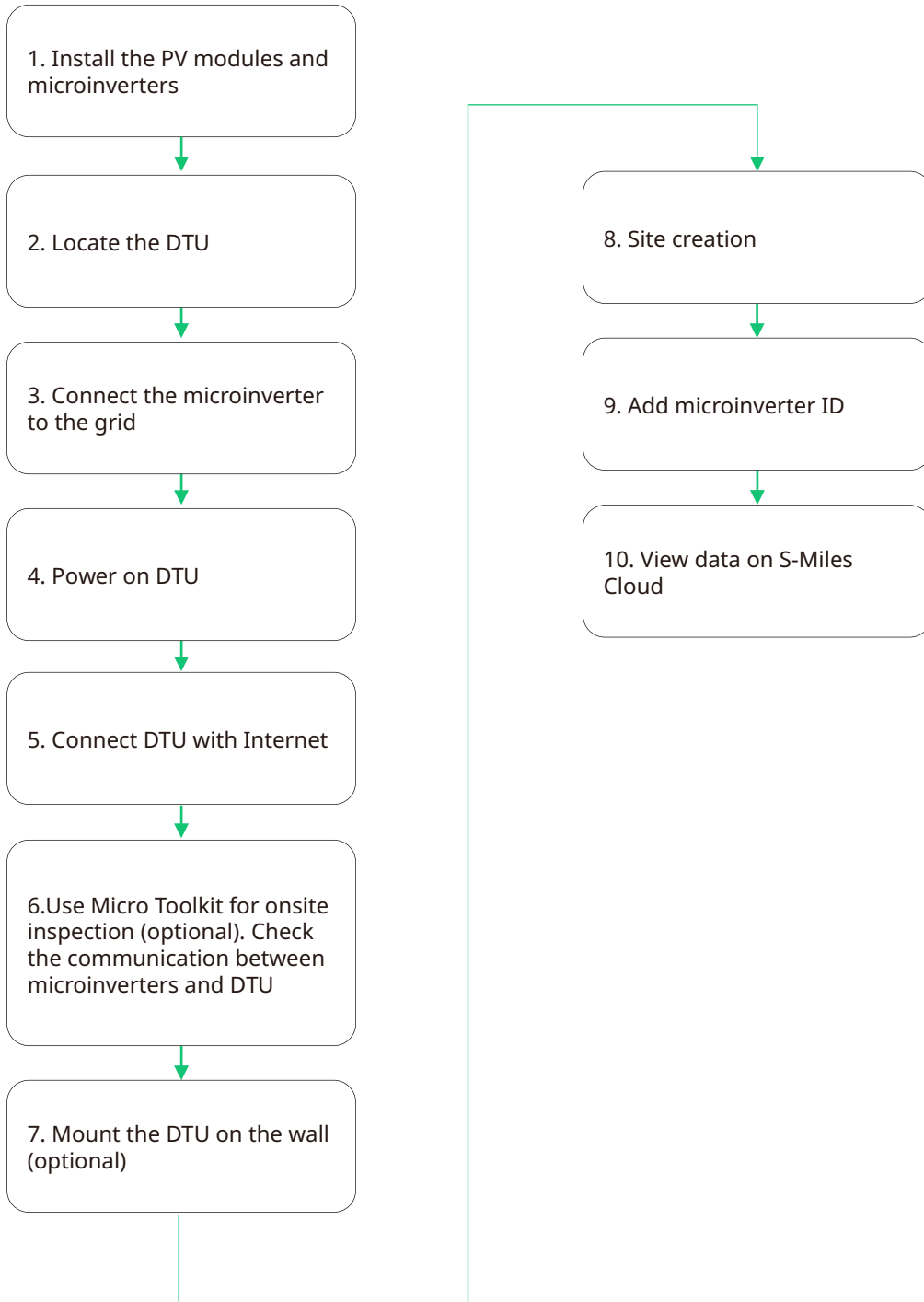

6. DTU Installation

6.1 Installation Instructions

- A) Check the box for the following items:
 - ✓ Hoymiles DTU-Pro-S (Two Antennas)
 - ✓ Adapter
 - ✓ Bracket
 - ✓ 5 Pin Plug
- B) Take DTU-Pro-S out from the box, check and tighten the antenna

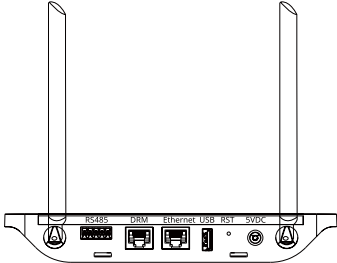

- C) Choose an installation location.
Installation principles:
 - ✓ Install the DTU on the top floor to increase the signal strength.
 - ✓ Install the DTU near the center of the PV array.
 - ✓ Install the DTU at least 0.5 m above the ground and more than 0.8 m away from the corner.

Note: To prevent signal attenuation, please do not install the DTU above metal or concrete.

- D) Choose the installation method

Option 1: Mount the DTU on the wall

- ✓ Mount the bracket on the wall. Please choose at least two screw holes (one from each side) to fix the bracket (the M4 screws need to prepare by the installer).
- ✓ Fix DTU-Pro-S to the bracket's upper buckle.
- ✓ Fix DTU-Pro-S to the bracket's lower buckle gently until you hear a click. Please make sure that the antennas are vertical to the wall.

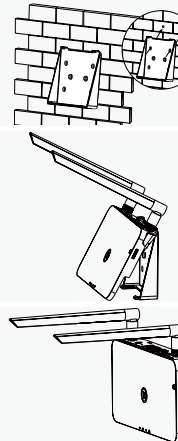

Option 2: Place the DTU on table. Please make sure the antennas are vertical to the table.

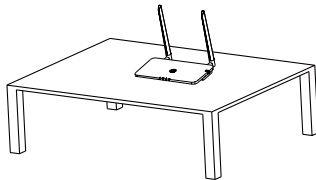

6.2 Online Setting

- A) Plug in the adapter to power on the DTU.
- B) Download the Hoymiles Installer app.



- C) Choose the way DTU-Pro-S connects to the Internet, and prepare the following items if needed.
 - ✓ For Wi-Fi: The network name and key of the Wi-Fi
 - ✓ For 4G version: 4G SIM card and APN
 - ✓ For Ethernet: Ethernet cable
- D) Set up the DTU connection on mobile phone.
 - ✓ Open the Installer app on smart phone/tablet and log in.
 - Click “O&M” on the bottom of the page and then “Network Config”.

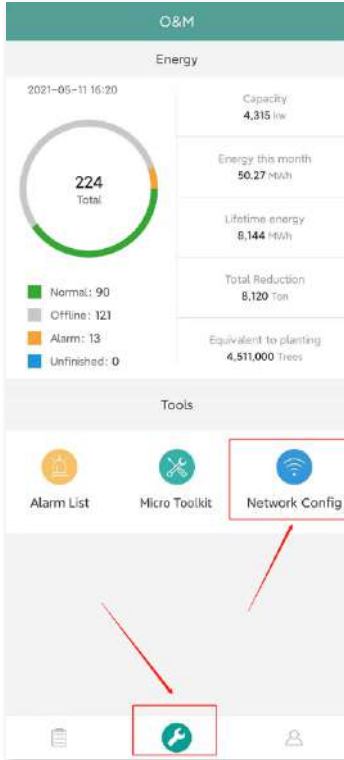

- ✓ Select the DTU’s wireless network and click “Connect”. (The network name of the DTU consists of DTUP and product serial number. In the following example, the DTU ID is 65200316 and the network name is DTUP-65200316.)

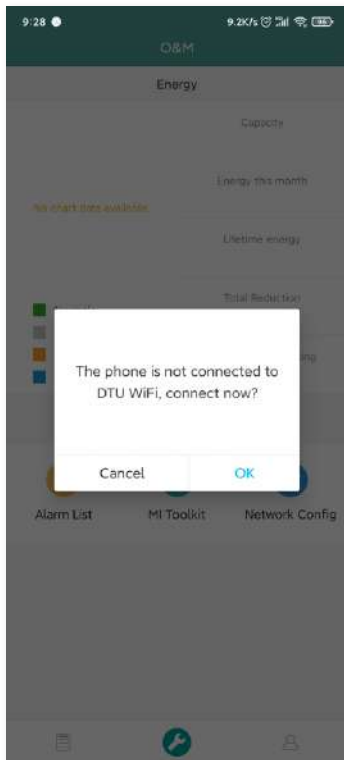

E) Set up the Internet

✓ For Ethernet

Connect the router to the DTU Ethernet port with a Lan cable.
Go back to "Network Config" interface and select "Ethernet".

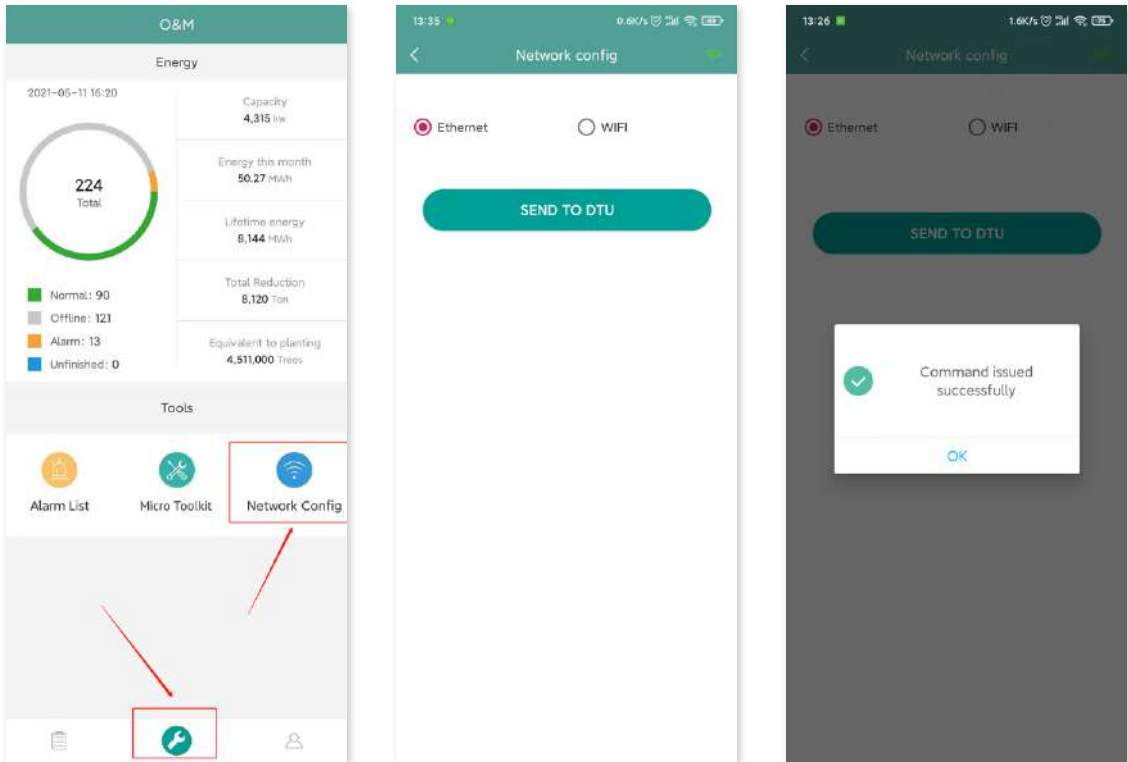

Click "Send to DTU" and a popup box will appear. Confirm and exit.

✓ For Wi-Fi

Go back to "Network Config" interface. Select "Wi-Fi" and complete the Wi-Fi configuration.

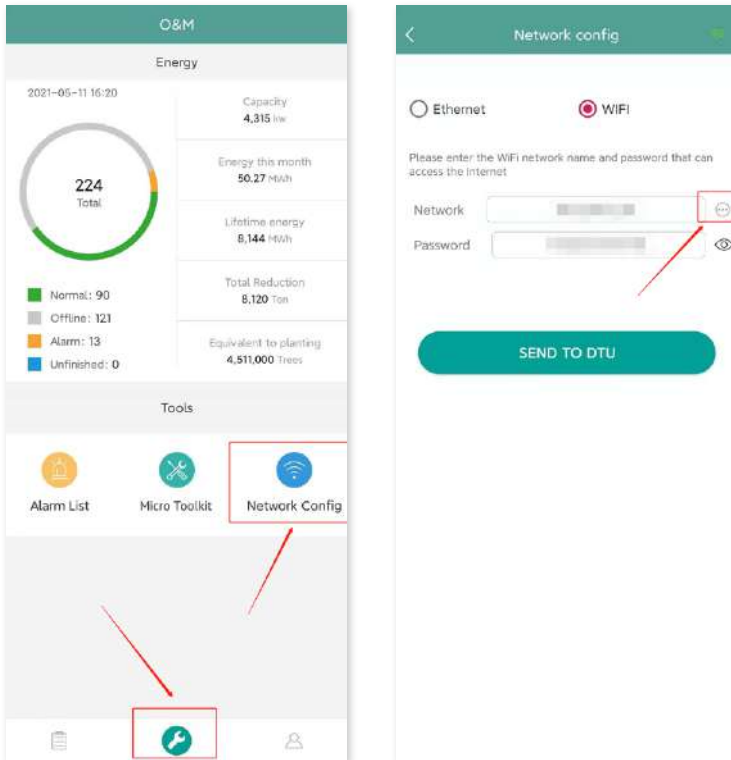

Select the available Wi-Fi and enter the password.

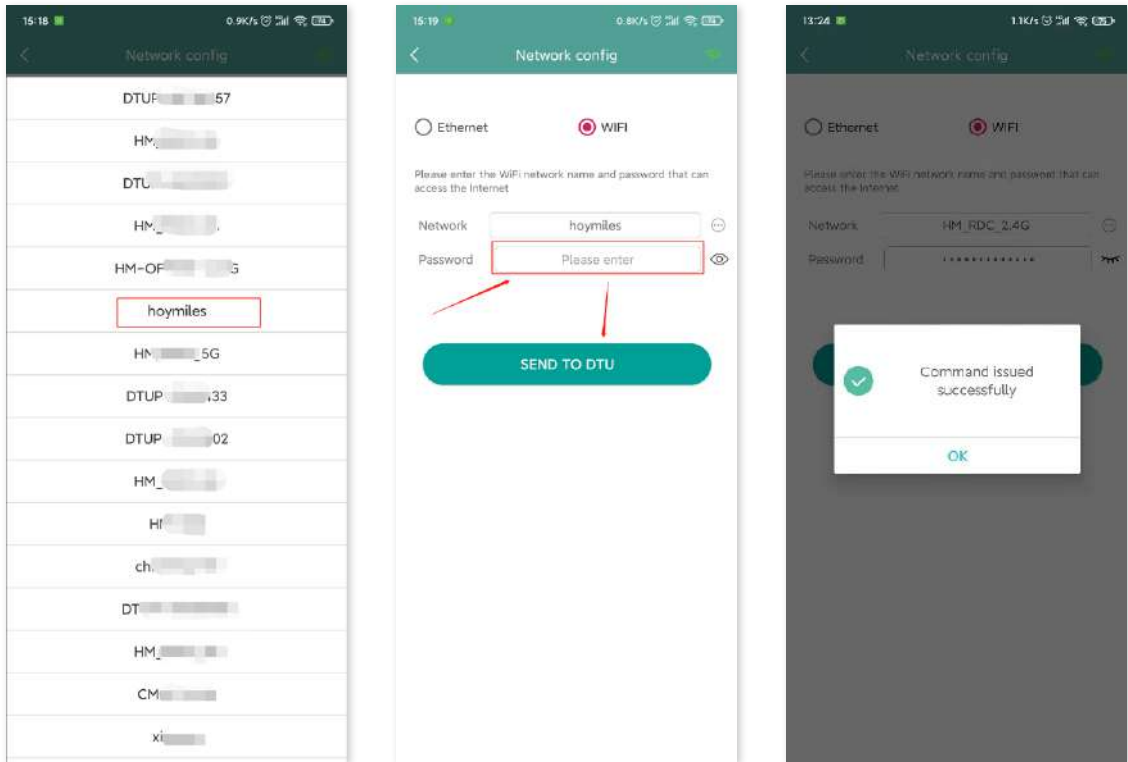

Click "Send to DTU" and a popup box will appear. Confirm and exit.

✓ For 4G

Insert the SIM Card into the SIM Card slot on the side of DTU until it clicks.

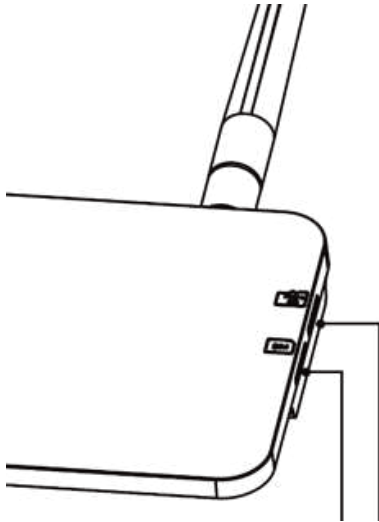

Go back to "Network Config" interface and select "4G".
 Please get APN information from your telecom operator and modify APN accordingly.

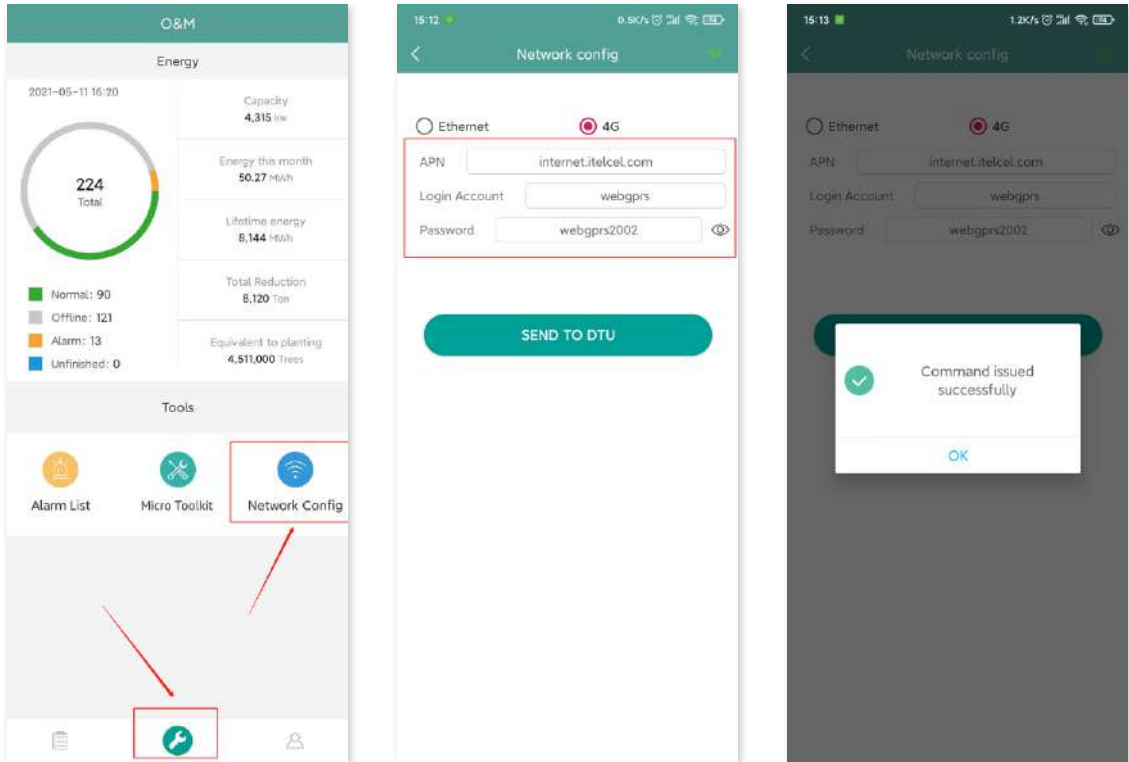

Click "Send to DTU" and a pop up box will appear. Confirm and exit.

Note: Once the command is successfully issued, you will exit the Network Config page and the DTU will start to connect to the network after 30 seconds.

6.3 Complete Installation Map

Please complete the installation map.

A) Peel the serial number label (as circled below) from the DTU and place it on the installation map.

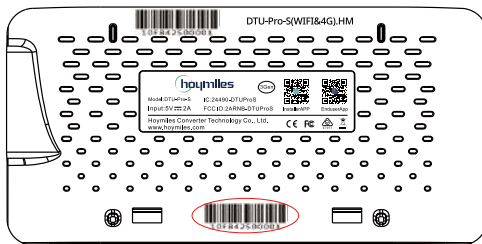

B) Complete system information of the installation map shown as follows.



7. Micro Toolkit

Micro Toolkit is one of the toolkits that come with the S-Miles Cloud app. It can be used for on-site inspection after the PV power station is complete, so that the operation of microinverter can be monitored without Site Creation.

7.1 Connect to the DTU

- ✓ Open the Installer app on smart phone/tablet and log in.
- ✓ Click “O&M” on the bottom of the page and then “Micro Toolkit”.

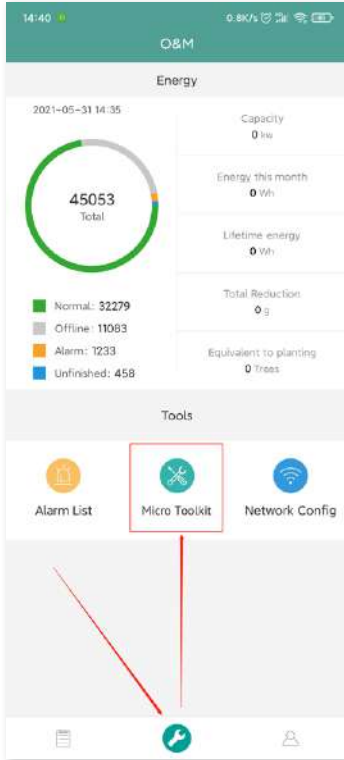

- ✓ Select the DTU’s wireless network and click “Connect”. (The network name of the DTU consists of DTUP and product serial number, and is password-free by default.)

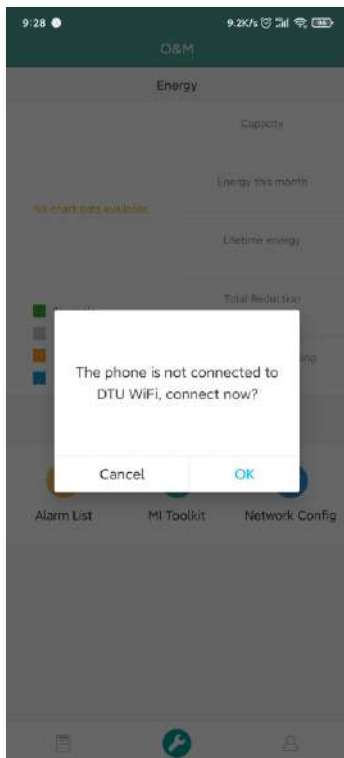

7.2 Field Commissioning and Data Viewing

7.2.1 Data Overview

1. Click O&M and enter Micro Toolkit.

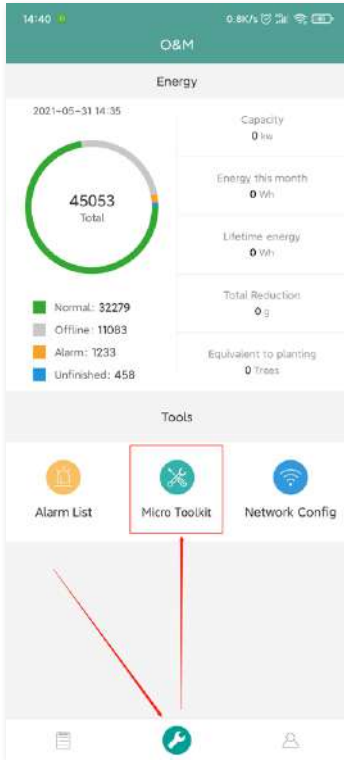

2. If you have already created the power station on the monitoring platform, you can directly view the data and information on the overview page.

7.2.2 Add Microinverter

If power station is not yet created on the platform, you need to type in microinverter SN to view power station data as instructed below.

1. Click "Power generation" button

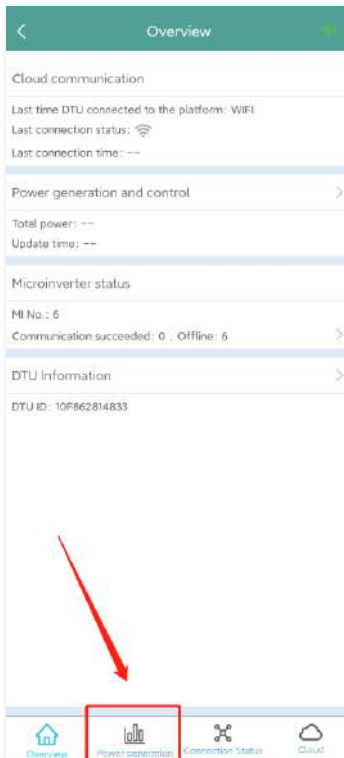

2. Press the “Add Device” button to add the microinverter to the list. (The microinverter added here is only used for on-site debugging, and it will not be uploaded to the server, nor can it replace the power station creation on S-Miles Cloud.)



3. You can add microinverter via “Automatic Search” or typing in the microinverter ID or scanning the ID.

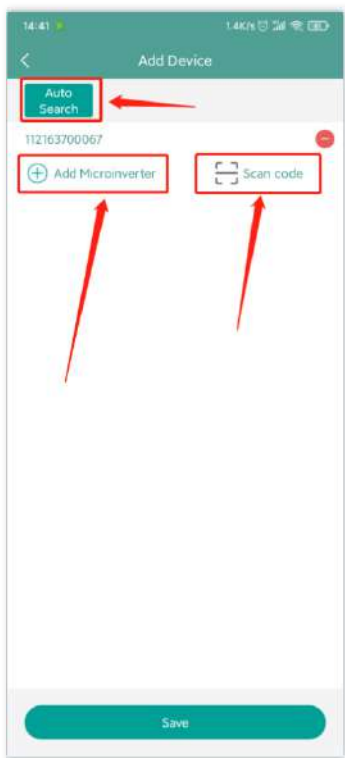

4. The search result of microinverters and microinverter added will be displayed in the list. Tap the button on the right if you want to delete it.

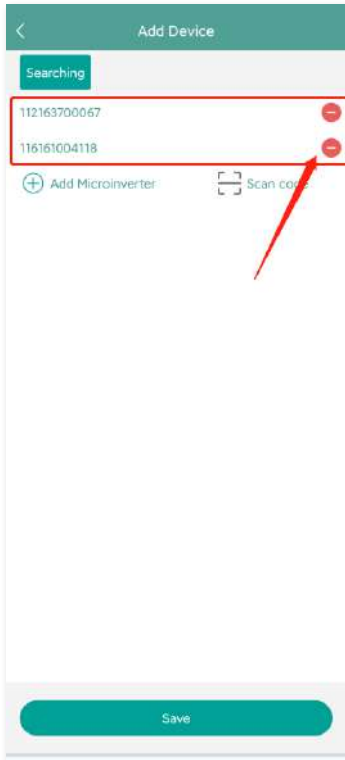

5. Confirm that the microinverter ID in the list is correct, and tap save.

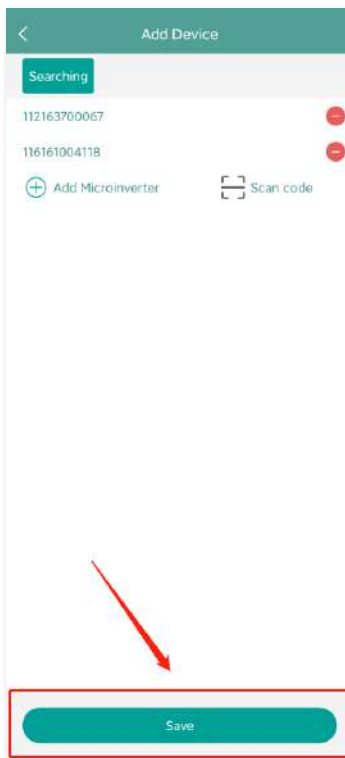

7.2.3 View Microinverter Data

1. Click “Power Generation”. You can see the list of the microinverter and PV power of each microinverter.



2. If you want to see more details of one microinverter, just click the serial number, then you can check the input and output data on the page shown as below.



Note: If the microinverter signal is so weak that the real-time data are not updated, move the DTU closer to the microinverter.

7.2.4 View Communication Status with Microinverter

1. Re-enter Micro Toolkit and tap “Connection Status”.

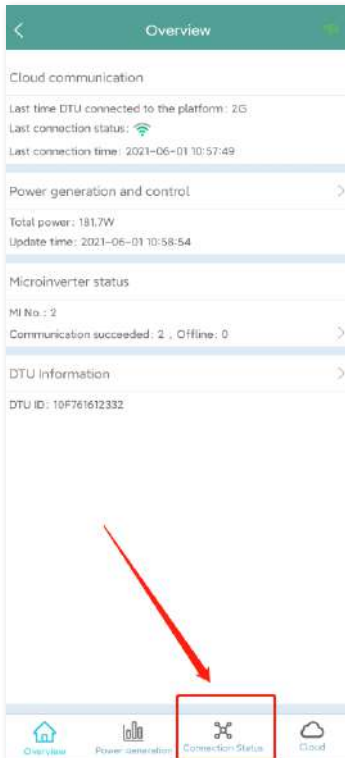

2. On this page, you can check the signal strength between the DTU and each microinverter. Tap the signal icon to enter the respective microinverter page (signal quality is constantly refreshing).

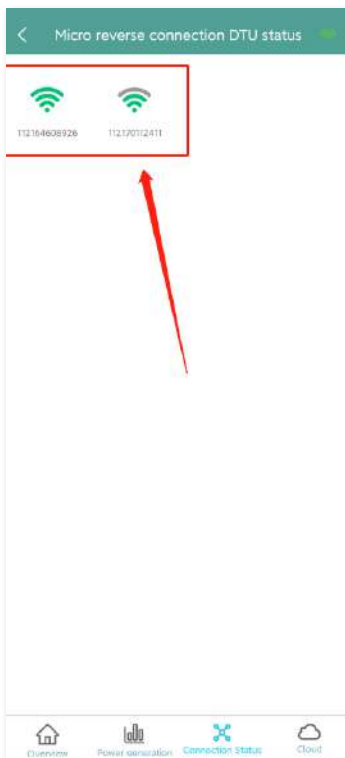

3. You can also Tap the button to switch the signal quality and real-time data page.



Note: If the microinverter has no signal, please check whether the microinverter is powered on or refer to the microinverter user manual for troubleshooting.

8. Site Creation on S-Miles Cloud

This is a brief description of how to create a new site. You can refer to “Quick Installation Guide for S-Miles Cloud Online Registration” for detailed account creation instructions.

8.1 Site Creation

1. Install Hoymiles Installer app by searching “Hoymiles” in the App Store (IOS) or the Play Store (Android).



2. Open the app and log in with your installer account and password. If you are a new installer with Hoymiles, please apply for an Installer account from your distributor in advance.

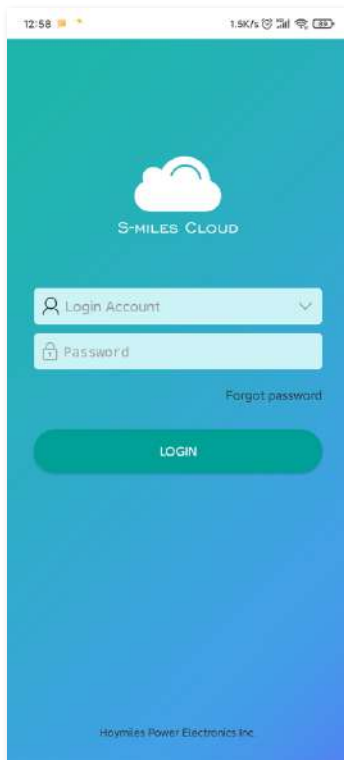

3. Select the “Station” tab on the bottom, and then select “⊕” on the right top side of the page to add station.



Fill in the station details and press “Next”. Select one from the three types of plant: Home Plant, Enterprise Plant, and Large Professional Plant.

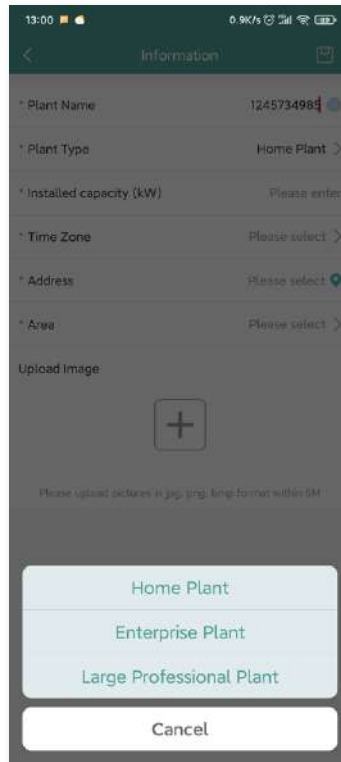
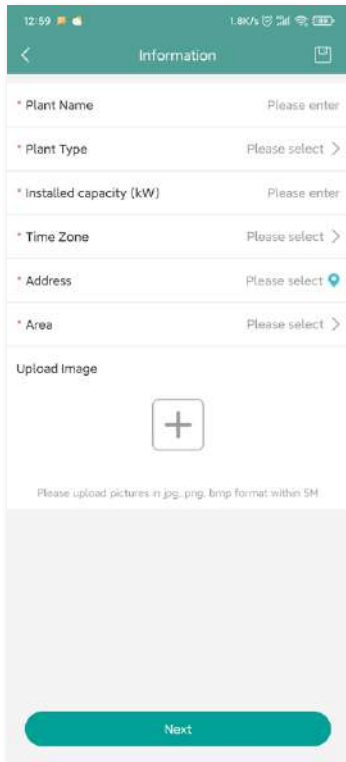

4. Select owner for the plant. Create a new one if there is none.

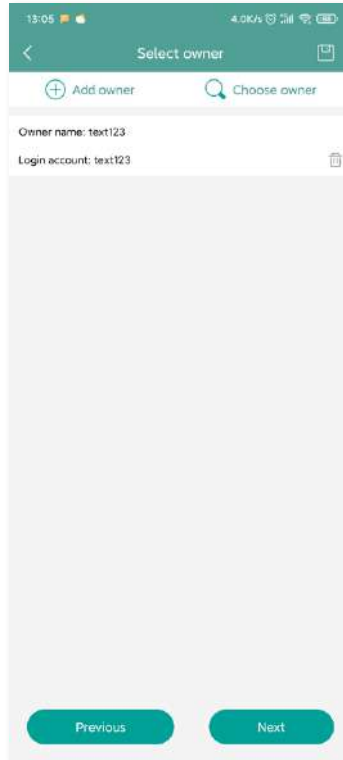
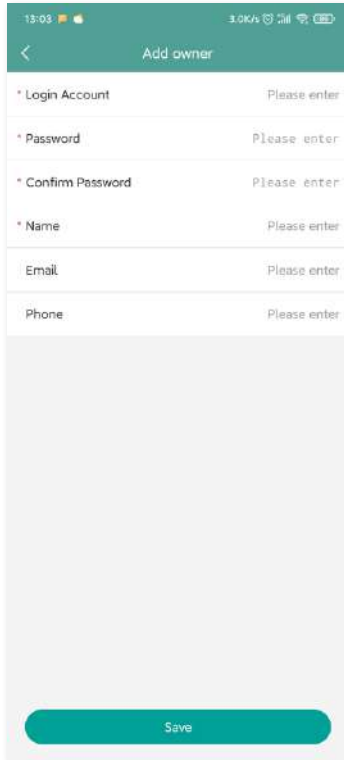
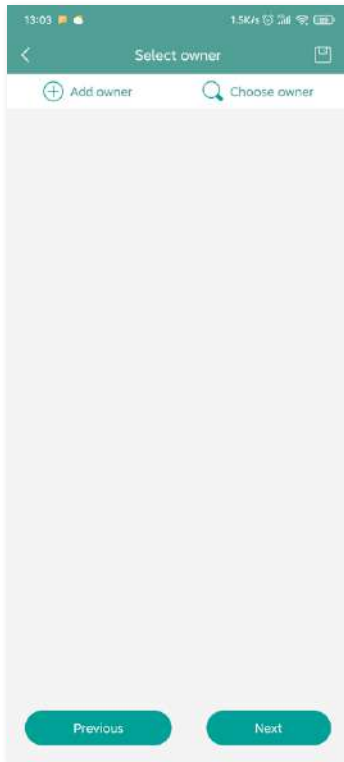

5. Press "Add DTU ID". Scan or manually input the DTU ID.

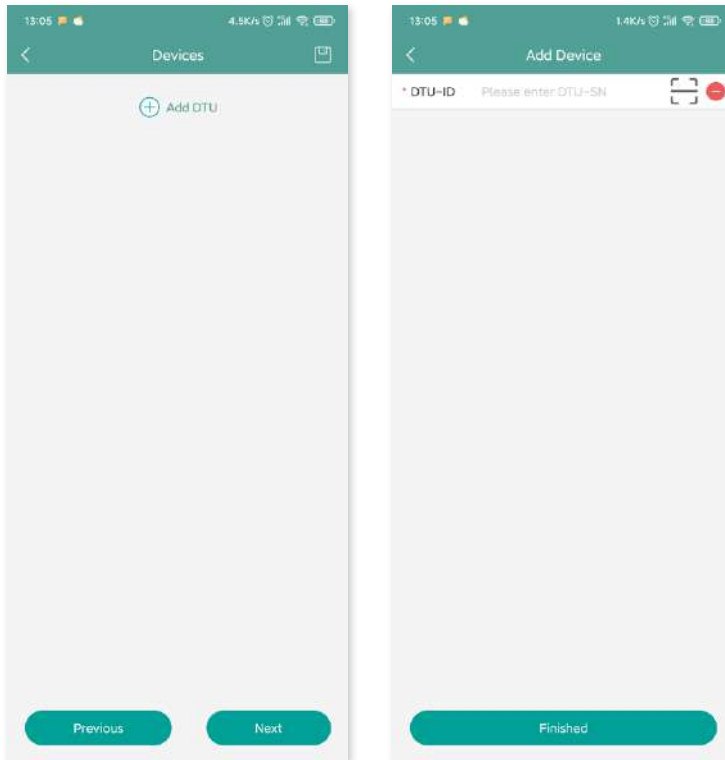

6. Scan or manually input the microinverter ID. Press "Finish" when all microinverter IDs have been input.

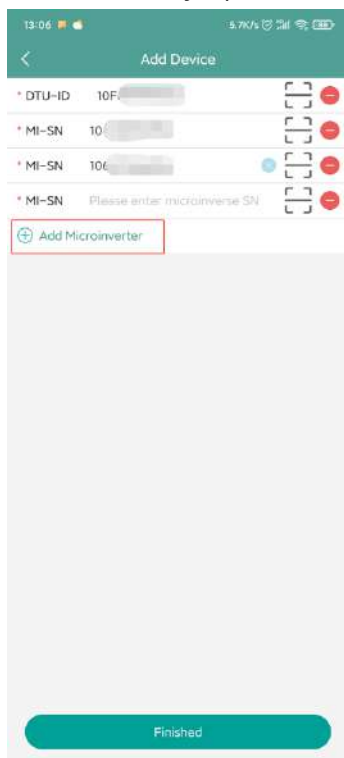

7. Customize the layout based on the installation (or click the tick box on the top right to select preset layouts). Then tap "Next".

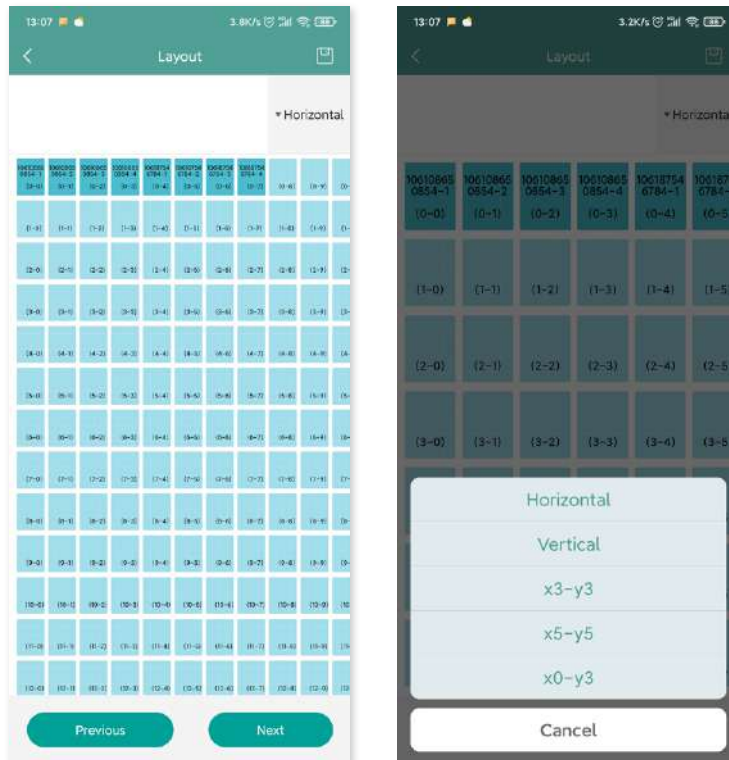

8. Save the design layout and fill in the information.

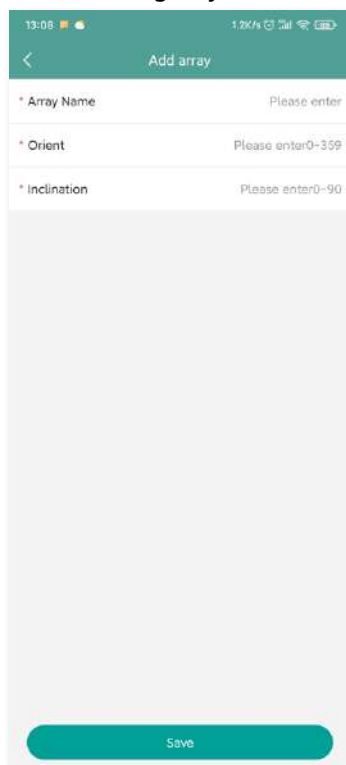

9. Upload a picture of the site and tap "Next".



10. Please enter the currency unit and your electricity price. Click the "Networking" button and tap "Save" to complete the site creation.

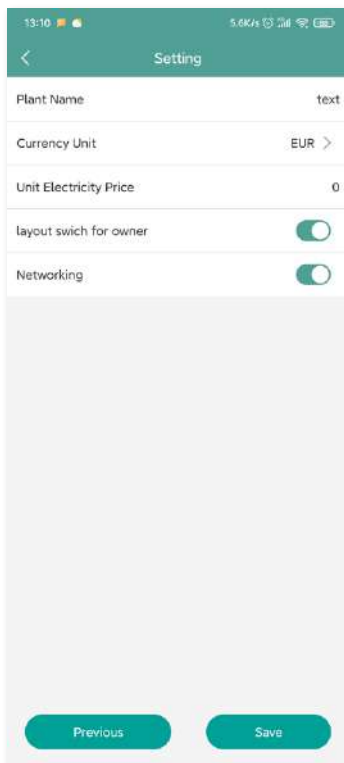

11. The new site will appear on the station list under the Installer account.

12. Please wait about 30 minutes, and the station will appear online where you can see the ID of all microinverters.

13. Networking will fail if the DTU is not powered on. Please tap networking again after the DTU is powered on.

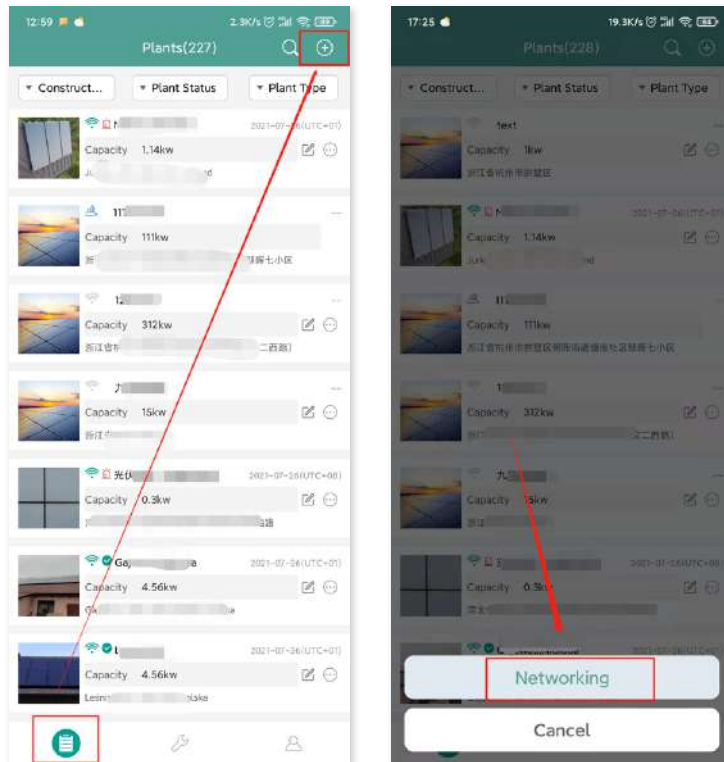

8.2 Customer Login

- A. Please download the End User app by searching “Hoymiles” in App Store (IOS) or Play Store (Android).
- B. Log in with the password and username that have been set up by the installer on the previous step.
- C. Customers will be able to view all details once the data start to upload. If it’s the first power station created, normally it takes around 30 mins for the data to come through.
- D. Customers can also view power generation details on the S-Miles Cloud monitoring platform at global.hoymiles.com.

8.3 Browse Station on Webpage

Log in to your account and browse the station on webpage.

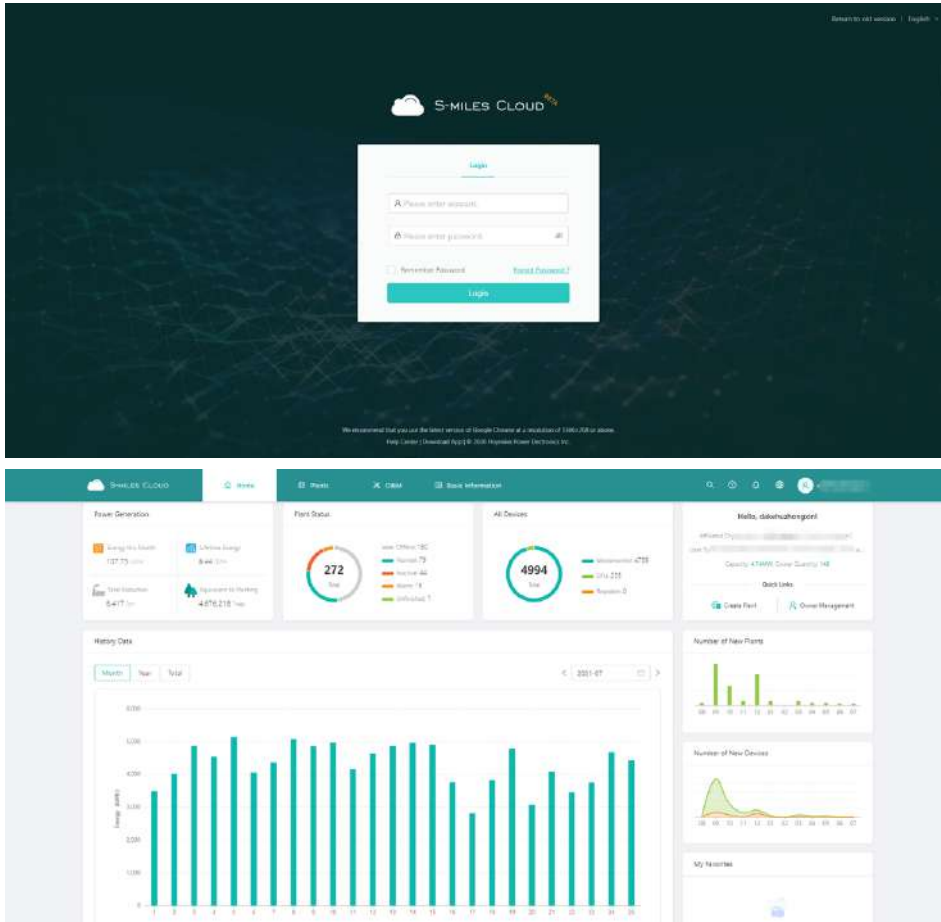

8.4 View Phone App

Download the app on your mobile phone and view station information.

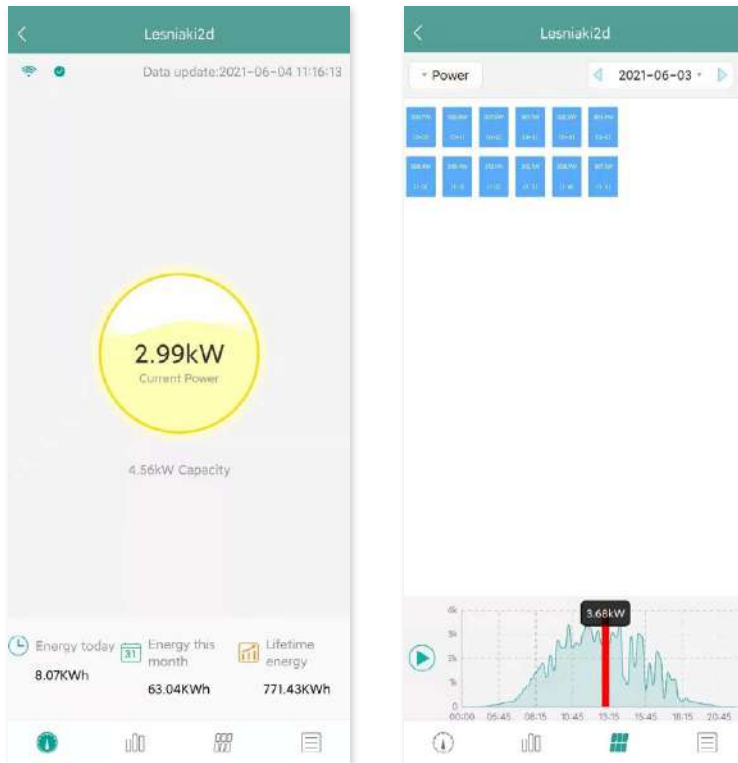

9. DTU Replacement

1. If you need to replace the original DTU, please complete the installation according to the instructions in this manual. Otherwise data on the monitoring platform may be lost.
2. Log in to your account on the web. Select “Devices > Action > Device Maintenance” for the plants that need a DTU replacement.

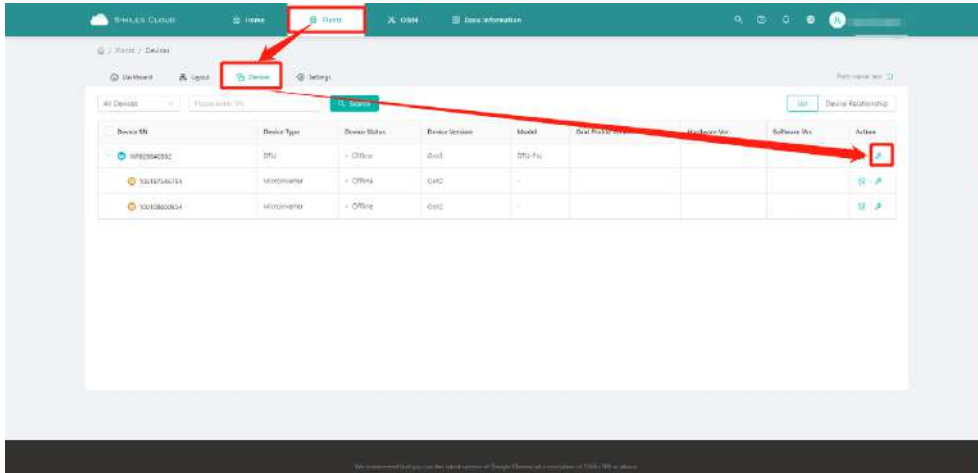

3. Click “Replace Device”, enter the current device SN and click “OK” to complete DTU replacement.

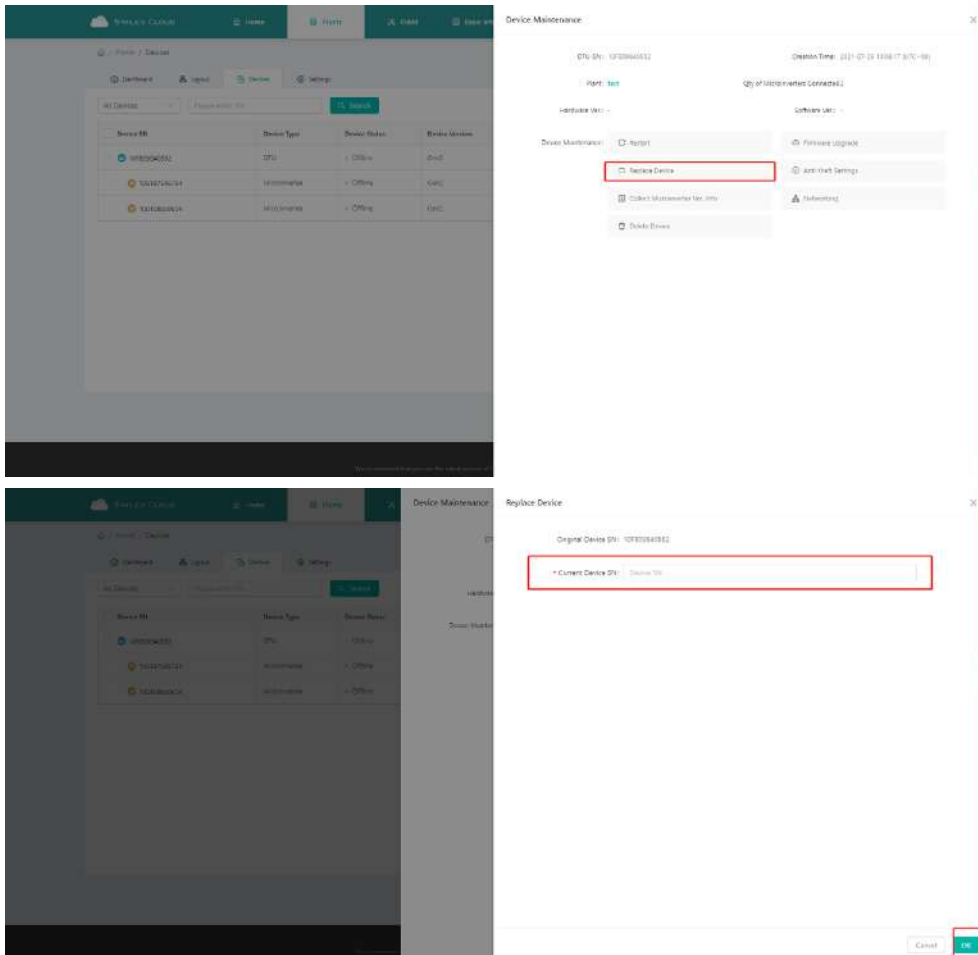









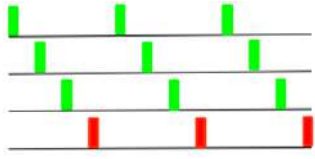







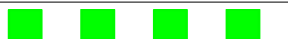

10. LED Indicators

You can also learn about the system status via LED indicators.

LED Mark	LED Color	Description
		DTU power on or power off
		Network communication
		Microinverter communication
		Fault State

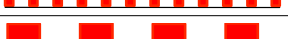
LED States

LED Indicator	Status	Description
All		Firmware upgrading
		Starting up
		DTU power on
		DTU power off
		DTU is communicating with Hoymiles S-Miles Cloud
		Internet disconnected
		Internet connected and server disconnected
		Local app connected
		DTU is connecting to microinverters
		No MI ID (Please create power station on the web)
		MI IDs Incomplete
		Normal
		DTU alarm occurred
		Microinverter alarm occurred
		Meter alarm occurred

11. Technical Data

Model	DTU-Pro-S (Wi-Fi Version)	DTU-Pro-S (4G Version)
Communication to Microinverter		
Signal		Sub-1G
Maximum distance (open space)		400m
Monitoring data limit from solar panels		99 ¹
Communication to S-Miles Cloud		
Ethernet		RJ45 × 1, 100Mbps
Wireless ²	Wi-Fi: 802.11b/g/n	4G: TDD-LTE, FDD-LTE 3G: SCDMA 2G: GSM/GPRS
Sample rate		Per 15 minutes
Communication to Peripherals		
RS485		COM × 1, 9600bps, Modbus-RTU
Ethernet		RJ45 × 1, Modbus-TCP
DRM (For AU/NZ only)		RJ45 × 1, DRM0/5/6/7/8
Interaction		
LED		LED Indicator × 4 – RUN, Cloud, MI, ALM
APP		S-Miles Toolkit
Power Supply (Adapter)		
Type		External adapter
Adapter input voltage/frequency		100 to 240 V AC / 50 or 60Hz
Adapter output voltage/current		5V / 2A
Power consumption	Typ. 1.5W / Max. 3.0W	Typ. 2.5W / Max. 5.0W
Mechanical Data		
Ambient temperature (°C)		-20°C to 55°C
Dimensions (W×H×D)		200mm×101mm×29mm (without antennas)
Weight		0.20 kg
Installation method		Wall mounting / Desktop mounting
Environmental rating		Indoor-IP20
Compliance		
Certificates		CE, FCC, IC, RCM, Anatel
Microinverter Compatibility		
Microinverter model		HMS series, HMT series

*1 This depends on the installation environment. Please refer to user manual for more details.

*2 Extended antenna is recommended if the DTU is installed inside a metal box or under a metal/concrete roof.